

HELİS DİŞLİ POMPALAR /HELICAL GEAR

VN SERİSİ SERIES

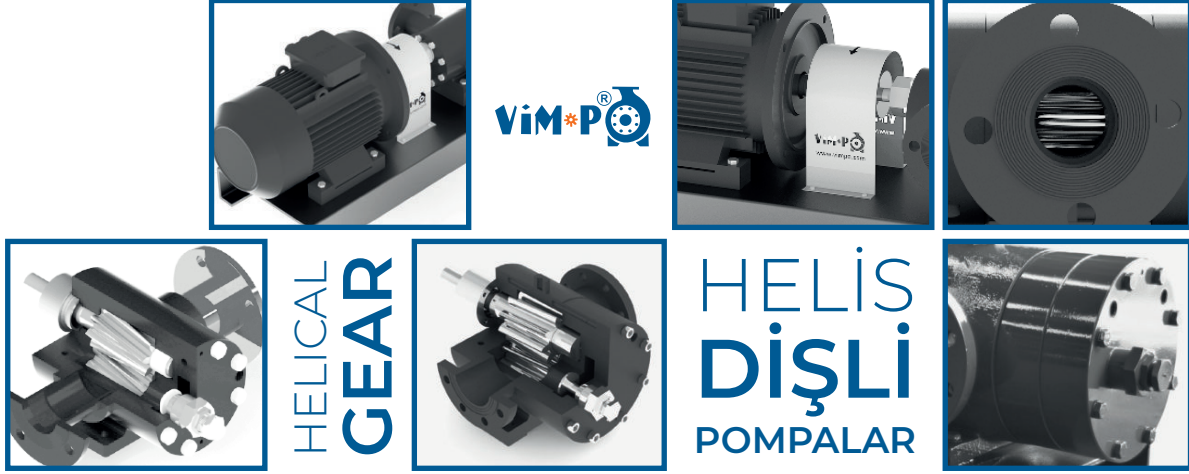

Ağır hizmet tipi çift helis dişli pompalar temiz, yağlama özelliği olan viskoz sıvıların 100,000 cSt, 200°C, 15 bar ve 50m³/saat'e kadar sessiz ve sabit akışlı kullanımı idealdir.

Entegre; aşırı basınç emniyet ventili, yumuşak veya mekanik salmastra, çift yönlü basma, 5m derinliğe kadar kendinden emiş özellikleri bulunmaktadır. Talep halinde daha yüksek basınç ve sıcaklıklarda çalışabilecek özel sıvıların basılabilmesi için yataklama ve pompa malzeme alternatifleri mevcuttur.

VN Series are ideal for the silent and consistent transfer of clean and lubricating viscous liquids with viscosity up to 100,000 cSt, at a temperature up to 200 °C, at a pressure up to 15 bar with capacity of up to 50m³/hour. These pumps are integrated with over-pressure relief valve, soft of mechanical seal, two way discharge ports, suction lift up to 5m depth. When required, alternative pump materials are also available for the transfer of the special liquids at higher temperatures and pressures.

POMPA TİPİ PUMP TYPE	GİRİŞ - ÇIKIŞ PORT SIZE	BASINÇ MAX. PRESSURE	KAPASİTE(m ³ /h) CAPACITY	GÜÇ (kW) POWER	RPM ROTATION	AĞIRLIK (kg) WEIGHT
2" VN 204	2"	15 Bar	11	5.5	950	34
2½" VN 305	2½"	15 Bar	17	5.5	950	48
3" VN 636	3"	15 Bar	35	11	950	116
4" VN 636	4"	15 Bar	35	11	950	116
3" VN 863	3"	15 Bar	50	15	950	125
4" VN 863	4"	15 Bar	50	15	950	125

Not: Verilen Kapasite ve Basınç değerleri pompa giriş ve çıkış ağzında olan değerlerdir.
Note: Capacity and Pressure values given are the values at the pump inlet and outlet.

HELİS DİŐLİ POMPALAR /HELICAL GEAR

2" VN

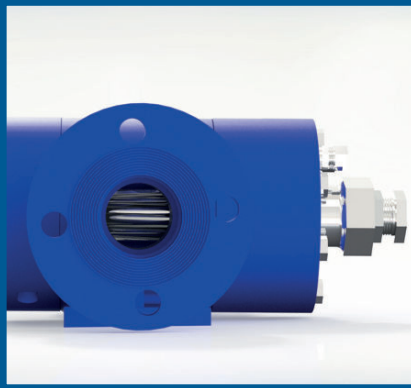
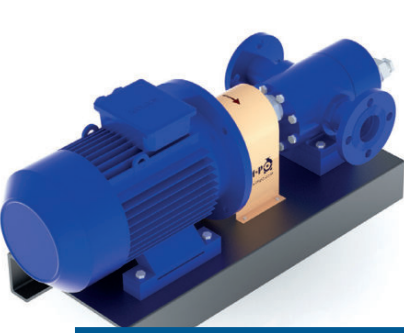

Pump Caharacteristic Graphs / Pompa Karakteristik Grafikleri

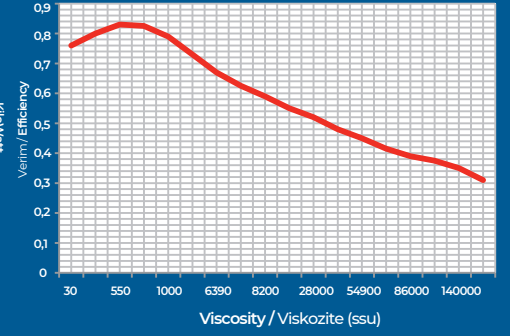
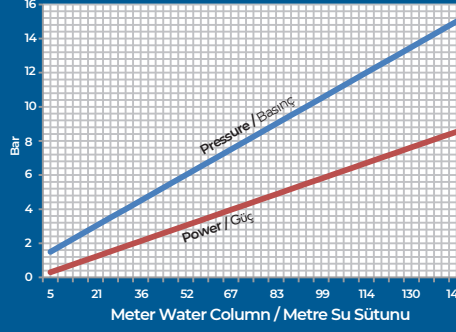

POMPA TİPİ
2" VN-204



GİRİŐ-ÇIKIŐ
2"



BASINÇ MAX.
15 BAR



KAPASİTE (m³/h)
11



GÜÇ (kW)
5.5



RPM
950



AĞIRLIK (kg)
34

2¹/₂" VN

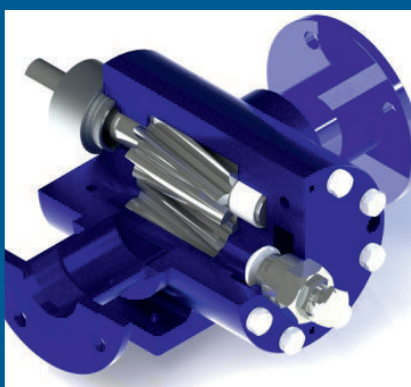
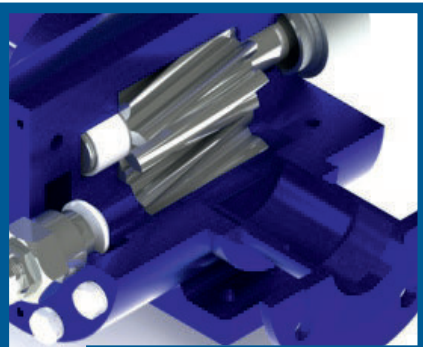

Pump Caharacteristic Graphs / Pompa Karakteristik Grafikleri

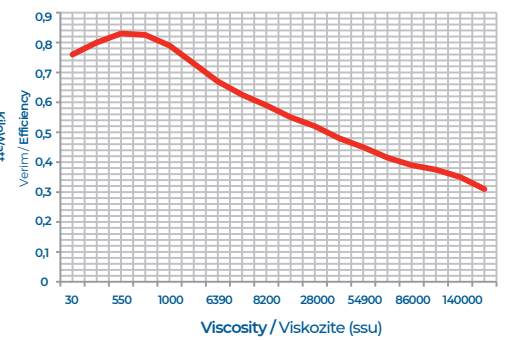
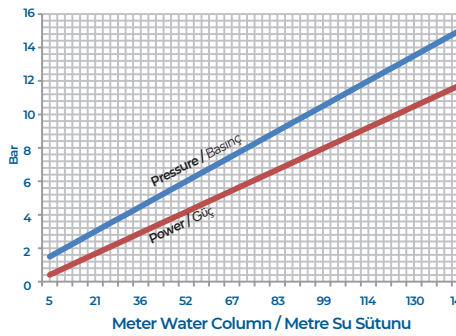

POMPA TİPİ
2¹/₂" VN-305



GİRİŐ-ÇIKIŐ
2¹/₂"



BASINÇ MAX.
15 BAR



KAPASİTE (m³/h)
17



GÜÇ (kW)
5.5



RPM
950



AĞIRLIK (kg)
48

HELİS DİŞLİ POMPALAR /HELICAL GEAR

Pump Caharacteristic Graphs / Pompa Karakteristik Grafikleri

3" VN

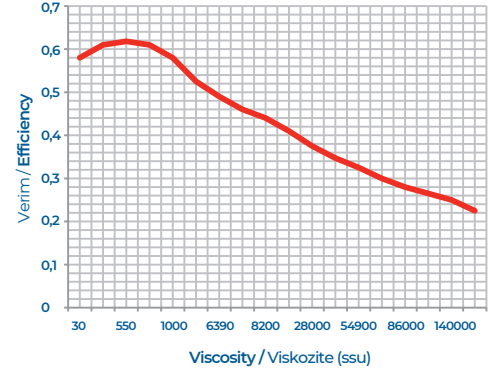
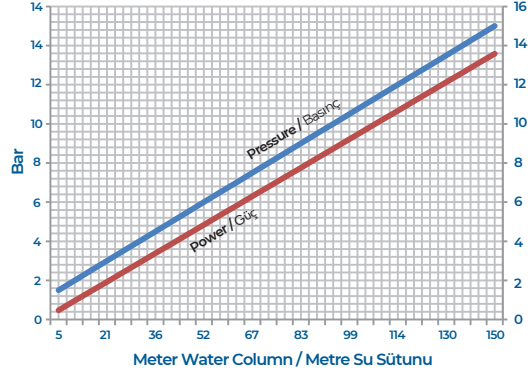

POMPA TİPİ
3"VN-636



GİRİŞ-ÇIKIŞ
3"



BASINÇ MAX.
15 BAR



KAPASİTE (m³/h)
35



GÜÇ (kW)
11



RPM
950



AĞIRLIK (kg)
116

Pump Caharacteristic Graphs / Pompa Karakteristik Grafikleri

4" VN

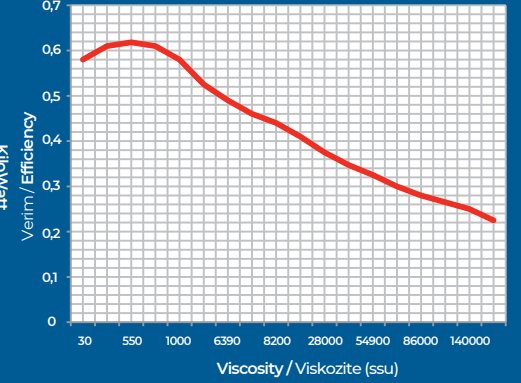
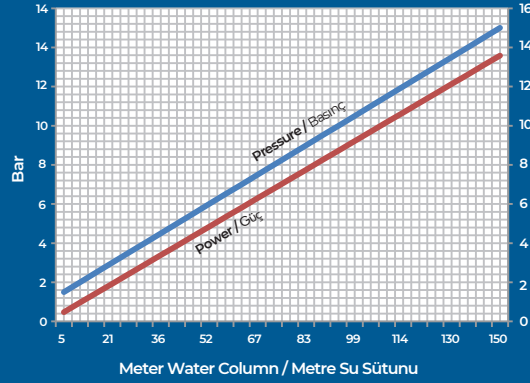

POMPA TİPİ
4"VN-636



GİRİŞ-ÇIKIŞ
4"



BASINÇ MAX.
15 BAR



KAPASİTE (m³/h)
35



GÜÇ (kW)
11



RPM
950



AĞIRLIK (kg)
116

HELİS DİŐLİ POMPALAR /HELICAL GEAR

3" VN



Pump Caharacteristic Graphs / Pompa Karakteristik Grafikleri

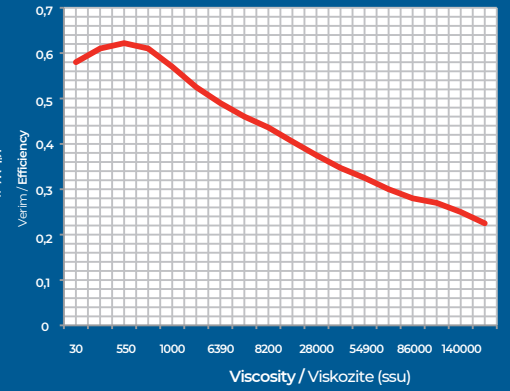
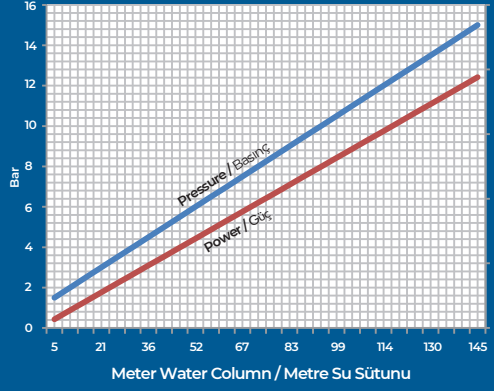

POMPA TİPİ
3" VN-863



GİRİŐ-ÇIKIŐ
3"



BASINÇ MAX.
15 BAR



KAPASİTE (m³/h)
50



GÜÇ (Kw)
15



RPM
950



AĞIRLIK (kg)
125

4" VN



Pump Caharacteristic Graphs / Pompa Karakteristik Grafikleri

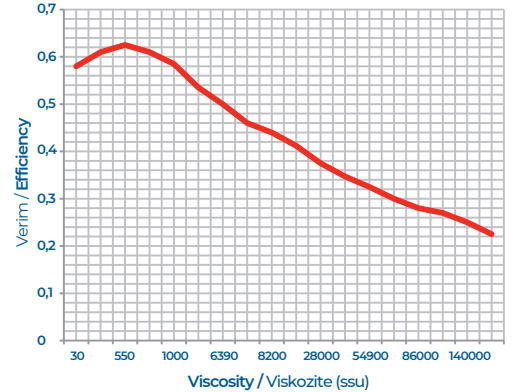
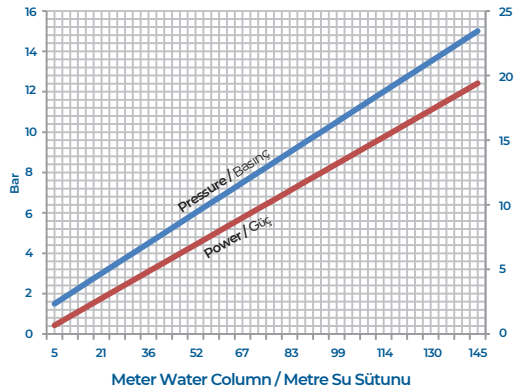

POMPA TİPİ
4" VN-863



GİRİŐ-ÇIKIŐ
4"



BASINÇ MAX.
15 BAR



KAPASİTE (m³/h)
50



GÜÇ (Kw)
15



RPM
950



AĞIRLIK (kg)
125